

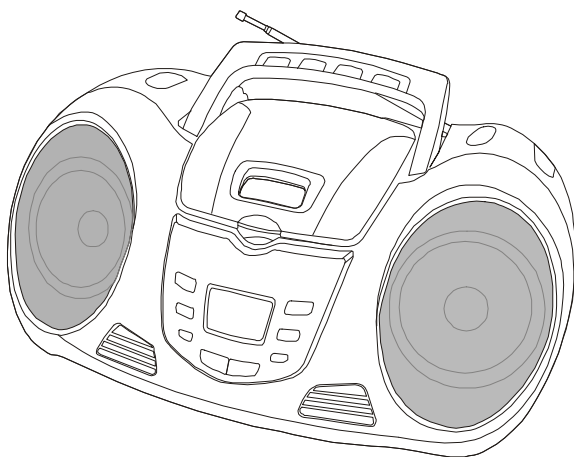

PORTABLE CD/MP3 PLAYER WITH AM/FM STEREO RECEIVER

MODEL CD-2086

OPERATING INSTRUCTIONS



- **PLAYS ALL MUSIC COMPACT DISCS, CD-R, CD-RW, MP3 & WMA RECORDED DISCS**
- **FULLY PROGRAMMABLE PLAYBACK**
- **60 SECOND (CD) & 120 SECOND (MP3) ANTI-SKIP PROTECTION**
- **ANALOG TUNER WITH DIGITAL READOUT AM/FM STEREO RECEIVER**
- **REPEAT ONE AND REPEAT ALL PLAY**
- **2 WAY POWER - AC/DC**
- **USES 8 SIZE "C" BATTERIES (not included)**

PLEASE READ CAREFULLY BEFORE USE

IB-CD2086(AD)-WM-E-031705

WARNING

TO PREVENT FIRE OR SHOCK HAZARD, DO NOT USE THE PLUG WITH AN EXTENSION CORD, RECEPTACLE OR OTHER OUTLET UNLESS THE BLADES CAN BE FULLY INSERTED TO PREVENT BLADE EXPOSURE. TO REDUCE THE RISK OF FIRE OR ELECTRIC SHOCK, DO NOT EXPOSE THIS APPLIANCE TO RAIN OR MOISTURE. TO PREVENT ELECTRICAL SHOCK, MATCH WIDE BLADE PLUG TO WIDE SLOT, FULLY INSERT.



The lightning flash with arrowhead symbol, within an equilateral triangle, is intended to alert the user to the presence of uninsulated "dangerous voltage" within the product's enclosure that may be of sufficient magnitude to constitute a risk of electric shock to persons.

CAUTION

**RISK OF ELECTRIC SHOCK
DO NOT OPEN**

WARNING: TO REDUCE THE RISK OF ELECTRIC SHOCK, DO NOT REMOVE COVER (OR BACK). NO USER SERVICEABLE PARTS INSIDE. REFER SERVICING TO QUALIFIED SERVICE PERSONNEL.



The exclamation point within an equilateral triangle is intended to alert the user to the presence of important operating and maintenance (servicing) instructions in the literature accompanying the appliance.

SEE BOTTOM OF THE SET.

IMPORTANT SAFETY INSTRUCTIONS

1. Read these instructions.
2. Keep these instructions.
3. Heed all warnings.
4. Follow all instructions.
5. Do not use this apparatus near water.
6. Clean only with dry cloth.
7. Do not block any ventilation openings, install in accordance with the manufacturer's instructions.
8. Do not install near any heat sources such as radiators, heat registers, stoves, or other apparatus (including amplifiers) that produce heat.
9. Do not defeat the safety purpose of the polarized or grounding-type plug. A polarized plug has two blades with one wider than the other. A grounding-type plug has two blades and a third grounding prong. The wide blade or the third prong is provided for your safety. If the provided plug does not fit into your outlet, consult an electrician for replacement of the obsolete outlet.
10. Protect the power cord from being walked on or pinched particularly at plugs, convenience receptacles, and the point where they exit from the apparatus.
11. Only use attachments/accessories specified by the manufacturer.
12. Unplug this apparatus during lightning storms or when unused for long periods of time.
13. Refer all servicing to qualified service personnel. Servicing is required when the apparatus has been damaged in any way, such as power-supply cord or plug is damaged, liquid has been spilled or objects have fallen into the apparatus, the apparatus has been exposed to rain or moisture, does not operate normally or has been dropped.
14. This appliance shall not be exposed to dripping or splashing water and that no object filled with liquid such as vases shall be placed on the apparatus.

IMPORTANT SAFETY INSTRUCTIONS

15. Servicing - Do not attempt to service this product yourself as opening or removing covers may expose you to dangerous voltage or other hazards. Refer all servicing to qualified service personnel.
16. Damage Requiring Service - Unplug this product from the wall outlet and refer servicing to qualified service personnel under the following conditions:
 - a) When the power-supply cord or plug is damaged.
 - b) If liquid has been spilled, or objects have fallen into the product.
 - c) If the product has been exposed to rain or water,
 - d) If the product does not operate normally by following the operating instructions. Adjust only those controls that are covered by the operating instructions as an improper adjustment of other controls may result in damage and will often require extensive work by a qualified technician to restore the product to its normal operation.
 - e) If the product has been dropped or damaged in any way.
 - f) When the product exhibits a distinct change in performance - this indicates a need for service.
17. Replacement Parts - When replacement parts are required, be sure the service technician has used replacement parts specified by the manufacturer or have the same characteristics as the original part. Unauthorised substitutions may result in fire, electric shock, or other hazards.
18. Safety Check - Upon completion of any services or repairs to this product, ask the service technician to perform safety checks to determine that the product is in proper operating condition.

ADDITIONAL SAFETY INSTRUCTIONS

1. **Power Sources** - The appliance should be connected to a power supply only of the type described in the operating instructions or as marked on the appliance.
2. **Wall or Ceiling Mounting** - The appliance should not be mounted to a wall or ceiling.
3. **Object and Liquid Entry** - Care should be taken so that objects do not fall and liquids are not spilled into the enclosure through openings.
4. **Servicing** - The user should not attempt to service the appliance beyond that described in the operating instructions. All other servicing should be referred to qualified service personnel.

Do not apply oil or petroleum products or solvents to any part of this set.

CAUTION

Use of controls or adjustments or performance of procedures other than those specified herein may result in hazardous radiation exposure.

This compact disc player is classified as CLASS 1 LASER PRODUCT as stated on the bottom of the set.

Please read important information displayed on the rating plate located on the bottom enclosure before connecting to AC Mains or any operation.

BATTERY SAFETY INSTRUCTIONS

CAUTION: TO REDUCE THE RISK OF FIRE OR PERSONAL INJURY OR DAMAGE TO YOUR SET, READ AND FOLLOW THESE INSTRUCTIONS.

1. Use only the type and size of batteries mentioned in the operating instructions booklet (batteries are not included with this set, please buy the proper batteries).
2. Do not dispose the batteries into a fire. The cells may explode. Check with local codes for possible special disposal instructions.
3. Do not open or mutilate the batteries. Released electrolyte is corrosive and may cause damage to the eyes or skin. It may be toxic if swallowed.
4. Be careful when handling batteries in order not to short the battery with conducting materials such as rings, bracelets and keys. The battery or conductor may over heat and cause burns.
5. Do not attempt to recharge non-rechargeable batteries. The batteries may leak corrosive electrolyte or explode.
6. Do not attempt to rejuvenate the batteries identified for use with this product by heating them. Sudden release of the battery electrolyte may cause burns or irritation to eyes or skin.
7. All batteries should be replaced at the same time. Mixing fresh and discharged batteries could increase internal cell pressure and rupture the batteries.
8. When inserting batteries into this product, the proper polarity (\oplus and \ominus) or direction must be observed. Reverse insertion of some or all of the batteries may result in battery electrolyte leakage or explosion.
9. Remove the batteries from this product if the product will not be used for a long period of time (several months or more) since during the period the batteries could leak, damaging the product.
10. Discard weak or dead batteries as soon as possible since they are more likely to leak in the product. Batteries should be replaced (depending on the product) when the display gets dim or if the Low Battery Indicator shows or if the sound gets distorted.
11. Do not store this product in high temperature areas. Batteries that are stored in a freezer or refrigerator for the purpose of extending shelf life should be protected from condensation during storage and defrosting. Batteries should be stabilized at room temperature prior to use after cold storage.
12. If this product does not operate normally, see TROUBLE SHOOTING in this instruction manual. If you can't resolve the problem, or if the product is damaged, refer to the LENOXX WARRANTY INFORMATION. Opening or removing covers may expose you to dangerous voltages or other risks. Incorrect reassembly can cause electric shock when the appliance is subsequently used.
13. If liquid leaks from the batteries, carefully wipe this liquid. Do not allow it to touch your skin, and discard the leaking batteries.
14. Do not mix batteries (OLD and NEW or CARBON and ALKALINE, etc.).
15. The use of rechargeable batteries is not recommended for this set because their voltage and life is lower than standard batteries.
16. Installation of batteries should be done by an adult only.

SAVE THESE INSTRUCTIONS

CHOOSING THE POWER SOURCES

You can use the AC power or batteries as a power source.

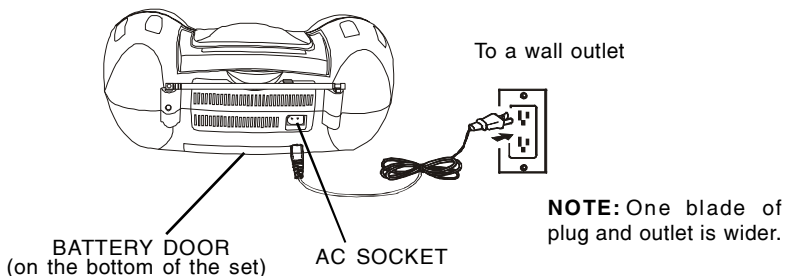

TIP:

- If the plug of the AC power cord does not match your outlet, do not force it. Reverse it and try again. The plug is polarized and only fits one way into the wall outlet and rear of the set.
- Replace all the batteries with new ones when the LCD display dims or the player stops operating. Before you replace all the batteries, be sure to take out the disc from the player and remember to check the Battery Safety Instructions on Page 3.
- If the discs do not play on batteries, this means the batteries are almost used up. But the radio may continue to play on these weak batteries because it uses less power than the disc player.

1. Connecting the AC power

Insert one end of the supplied AC power cord into the socket located at the rear of the set, and the other end into the 120V, 60 Hz standard household outlet.

2. Using the player on batteries

Insert 8 size “C” batteries (not supplied) into the battery compartment as shown. Observe (+) and (-) polarities.

To use the player on batteries, disconnect the AC power cord from both the outlet and the back of the player.

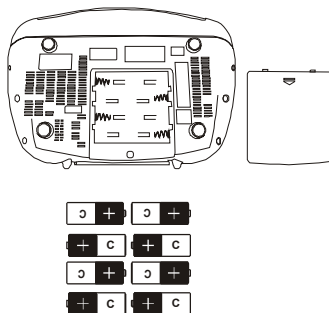

PLAYING A CD

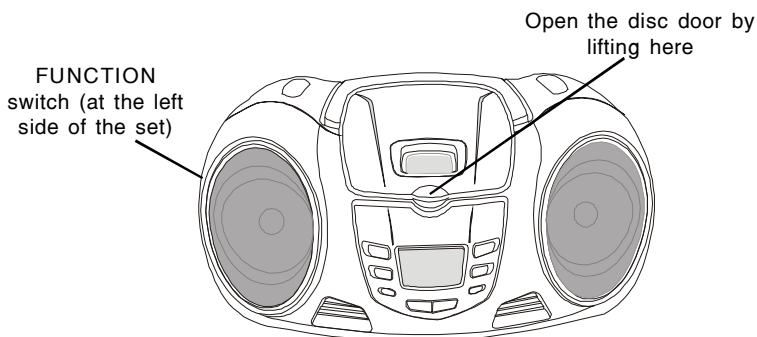

Connect the supplied AC power cord or batteries (refer to page 4).

1

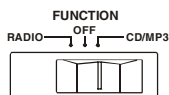

Slide the FUNCTION switch to the CD/MP3 position (power on), the LCD display will be on, and the word "READING" will show in the display.



2

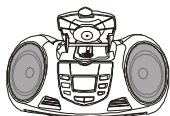

Lift the CD DOOR to open it and push a CD down onto the center spindle. The label side of the CD disc should face upward.



3



Close the CD DOOR. The display will show the total tracks and total playing time of that CD, then the player will begin to play automatically.

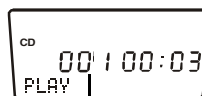

Track number currently playing

TIP:

1. "NO DISC" will show in the display if there is no CD disc in the CD compartment or if the CD disc is upside down.
2. "OPEN" will show in the display when the CD DOOR is opened.

USE THESE BUTTONS FOR ADDITIONAL OPERATIONS



Elapsed playing time of the current track

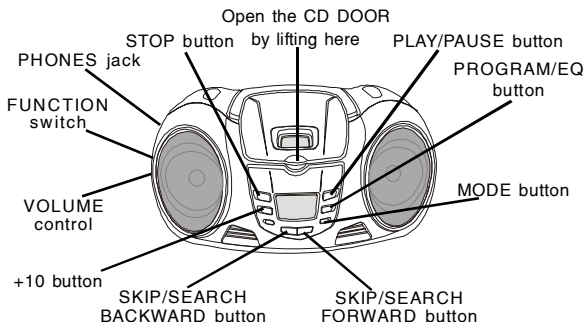

TIP

- When the CD play is paused, the word "PAUSE" will show in the display, the elapsed playing time of the currently playing track will flash and no music will play.
- To resume play, press the PLAY/PAUSE button again.
- If you just start to play a disc, the music may stop or skip for a few seconds. If the music is playing for a few minutes and has time to load, the music will not skip.

To	Press or Adjust
Adjust the volume	VOLUME control
Stop playback	STOP button
Pause playback	Press PLAY/PAUSE, the word "PAUSE" will show in the display and the elapsed playing time of the currently playing track will flash during pause. Press again to resume play after pause.
Go to the next track	▶▶ SKIP/SEARCH FORWARD
Go back to the previous track	◀◀ SKIP/SEARCH BACKWARD
Go to the next 10th track	Press the +10 button.
Locate a point in a song	◀◀ or ▶▶ Press and hold down while playing till you find the point.
Remove the CD	Press the STOP button first, then lift the CD DOOR.
Turn off the power	Slide the FUNCTION switch to the OFF position, LCD display turns off.
To enjoy the music without disturbing others	Insert your headphones (not included) plug into the PHONES jack.

CD REPEAT, INTRO AND RANDOM PLAY

You may have repeat, intro and random play functions by pressing the MODE button. Press the MODE button several times, the display will show the followings in turn:

REPT 1 → REPT ALL → INTRO → RANDOM → NORMAL PLAY

Single Track Repeat

Plays one song over and over till you press STOP.

Select the song you want to repeat with either of the SKIP/SEARCH buttons (◀◀ or ▶▶), or +10 button. Press the MODE button once, **REPT 1** will show in the display.

The song currently playing will repeat over and over until you press the STOP button.

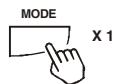

All Tracks Repeat (Disc Repeat)

Repeats all songs in order till you press STOP.

Press the MODE button twice, **REPT ALL** will show in the display.

All the songs will keep playing in sequence 1, 2, 3, etc. and when finished, the player will start all over again until you press the STOP button.

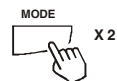

Intro Play

This plays the first 10 seconds of each song in sequential order.

Press the MODE button three times, **INTRO** will flash in the display. Press the PLAY/PAUSE button once, the first 10 seconds of each song on the CD will play in sequential order, **INTRO** will stop flashing and show in the display.

When you find a song you like, press the PLAY/PAUSE button again, **INTRO** will not show in the display, normal play will be resumed, that song (and the following songs) will play normally.

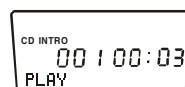
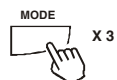

Random Play

This plays the songs on the disc in random order.

Press the MODE button four times, **RANDOM** will flash in the display. Press the PLAY/PAUSE button once, the player begins random play, **RANDOM** will stop flashing and show in the display.

Press the SKIP/SEARCH button (▶▶) to skip to the next random song.

To quit random play, press the MODE button once again, the player will play normally.

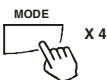

CD PROGRAMMED PLAY

You can make a program up to 20 tracks in the specified order you want them to be played.

Programming Example									
Program Number	1	2	3	4	5	6	7	8	etc.
Track Number (song number)	2	5	8	1	2	4	1	1	etc.

- Slide the FUNCTION switch to the CD/MP3 position. Make sure the set is in the **STOP** mode.
- Press the PROGRAM/EQ button once. The letters "**PROG**" will show in the display, and the letters "000" will flash in the display .
- Press the SKIP/SEARCH buttons (**⏮** or **⏭**) or +10 button to select the tracks to be programmed in the order that you want.
- Press the PROGRAM/EQ button to confirm. The program number 2 will now show in the display, ready for your next selection of track.
- Repeat above steps 3 and 4. You can program up to 20 tracks.
- After programming is finished, press the PLAY/PAUSE button to start programmed play.



Program number

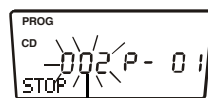

Track number

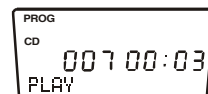

NOTE:

- Programming can only be done in **STOP** mode.
- The programmed memory will be lost if the STOP button is pressed twice, or the alkaline batteries are exhausted or removed, or AC power is shut off, or the CD DOOR is opened.
- The player will stop automatically after all the programmed tracks have been played.

To change the current program

Just create a new program following the above programming procedure.

To cancel Programmed Play

Press the STOP button twice, the symbol **PROG** will disappear from the display.

EQUALIZER FUNCTION

During play, you may select the tone type by pressing the PROGRAM/EQ button to choose the tone type. The display will show what you selected:

DBB, POP, CLASSIC, JAZZ, ROCK or NORMAL.

MP3 PLAYBACK

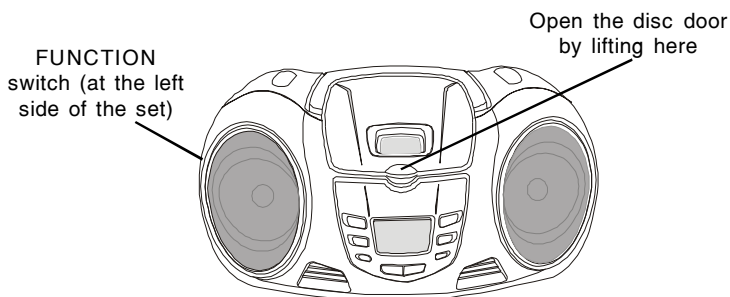

Connect the supplied AC power cord or batteries (refer to page 4).

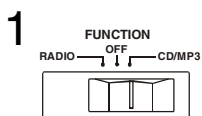

Slide the FUNCTION switch to the CD/MP3 position (power on), the LCD display will be on, and the word "READING" will show in the display.

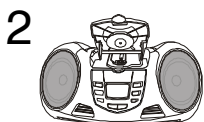

Lift the CD DOOR to open it and push an MP3 disc down onto the center spindle. The label side of the disc should face upward.

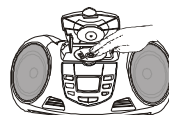

Close the CD DOOR. The display will show the total albums and total tracks of that MP3 disc, then the player will begin to play automatically.

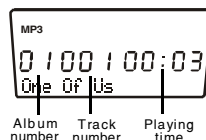

General Information

1. Usually, you must "write" your own MP3 disc on your computer's CD writer. Or, you may buy pre-recorded MP3 discs from some "on line" sources.
2. When saving songs (audio files) onto your CD-R (or CD-RW), you must save them as ".MP3" (DOT MP3) or ".WMA" (DOT WMA) files. Do not save them as .DOC or .TXT, .PDF etc. when downloading, converting or saving files as MP3 or WMA files. Also, the files must be recorded in MP3 or WMA format.
3. Do not save TXT files as ".MP3" files because they will not play and they may interfere with the set.
4. Do not attempt to combine normal CD audio tracks and MP3 tracks onto one CD because the set will only recognize the audio tracks and play those, but you can combine MP3 tracks & WMA tracks onto one CD.

OTHER MP3 OPERATIONS

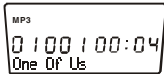
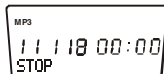
Operation	Press	Display window shows
To pause play	PLAY/PAUSE button	
To release pause and resume play	PLAY/PAUSE button	
To stop	STOP button	
To turn off the power	STOP button once and slide the FUNCTION to OFF position.	
To skip to the next track(s)	SKIP/SEARCH FORWARD button ►► once (or repeatedly)	
To skip to the next 10th track(s) quickly	Press the +10 button once, every time you press it, the player will skip to the next 10th track or the end track of the album.	
To skip to the previous track(s)	SKIP/SEARCH BACKWARD button ◄◄ once (or repeatedly)	
To go ahead at high speed (search)	Keep SKIP/SEARCH FORWARD button ►► depressed and release it when the desired music section of the disc is found.	
To go back at high speed (search)	Keep SKIP/SEARCH BACKWARD button ◄◄ depressed and release it when the desired music section of the disc is found.	
To change the ALBUM	Press the ALBUM button during play or in STOP mode, the album number flashes. Press the SKIP/SEARCH buttons (◄◄ or ►►) to choose the album. Press the PLAY button to start the selected album play.	
To change the Tone type	Press the PROGRAM/EQ button to choose the tone type during play. The display will show what you selected: DBB, POP, CLASSIC, JAZZ, ROCK or NORMAL.	

TIP:

1. " NO DISC " will show in the display if there is no disc in the CD compartment or the MP3 disc is upside down.
2. " OPEN " will show in the display if the CD DOOR is opened.
3. It may take about 10 to 30 seconds to read the disc depending on how many albums and songs are recorded on your MP3 disc.

MP3 REPEAT, INTRO AND RANDOM PLAY

You may have repeat, intro or random play functions by pressing the MODE button. Press the MODE button several times, the display will show the followings in turn:

REPT 1 → REPT DIR → REPT ALL → INTRO → RANDOM → NORMAL PLAY

Single Track Repeat

Plays one song over and over till you press the STOP button. Select the song you want to repeat with either of the SKIP/SEARCH buttons (◀◀ or ▶▶) or +10 button. Press the MODE button once, **REPT 1** will show in the display. The song currently playing will repeat over and over till you press the STOP button.

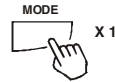

All Tracks Repeat (Directory Repeat)

Repeats all single album songs in order till you press the STOP button.

Select the directory (or album, folder) that you want to repeat with ALBUM button and the SKIP/SEARCH buttons (◀◀ or ▶▶). Press the PLAY/PAUSE button, then press the MODE button twice, **REPT DIR** will show in the display.

All the songs of that directory will keep playing in sequence 1, 2, 3, etc. and when finished, the player will start all over again until you press the STOP button.

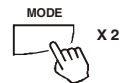

All Tracks Repeat (Disc Repeat)

Repeats all songs in order till you press the STOP button. Press the MODE button three times, **REPT ALL** will show in the display.

All the songs of the MP3 disc will keep playing in sequence 1, 2, 3, etc. and when finished, the player will start all over again until you press the STOP button.

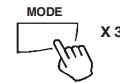

Intro Play

This plays the first 10 seconds of songs in sequential order. Press the MODE button four times, **INTRO** flashes in the display.

Press the PLAY/PAUSE button, the first 10 seconds of each song on the MP3 disc will play in sequential order, **INTRO** will stop flashing and show in the display.

When you find a song you like, press the PLAY/PAUSE button again, normal play will be resumed, that song (and the following songs) will play **NORMALLY**.

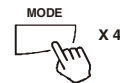

Random Play

This plays the songs on the disc in random order. Press the MODE button five times, **RANDOM** will flash in the display.

Press the PLAY button, this will play all of the songs in random order selected by the player, **RANDOM** will stop flashing and show in the display.

Press the SKIP/SEARCH button (▶▶), to skip to the next random song.

To quit random play, press the MODE button again, the player will resume play normally.

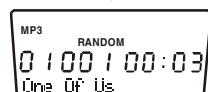
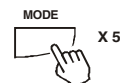

MP3 PROGRAMMED PLAY

The tracks (songs) on the disc can be programmed (arranged in advance) to play in any order you prefer (up to 20 tracks can be programmed).

Programming Example									
Program Number	1	2	3	4	5	6	7	8	etc.
Album Number (title number)	3	6	10	4	1	7	2	5	etc.
Track Number (song number)	3	5	8	1	2	4	1	1	etc.

During programming, the symbol "PROG" shows in the display. To program play in your preferred order, follow steps below:

- Slide the FUNCTION switch to the CD/MP3 position. Make sure the set is in **STOP** mode (the total album number and track number show in the display).
- Press the PROGRAM/EQ button, the symbol "PROG" will show in the display and the album number "01" will flash.

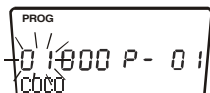

- Press the SKIP/SEARCH (◀◀ or ▶▶) buttons to select the title number 3 (example).

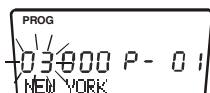

- Press the PROGRAM/EQ button to confirm. Title 3 is now selected, and the display will show:



- Press the SKIP/SEARCH (◀◀ or ▶▶) or +10 button to select the track number (example 1).

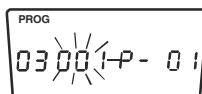

- Press the PROGRAM/EQ button to confirm. Track 1 is now programmed. The program number 2 will show in the display, ready for the next selection of track.

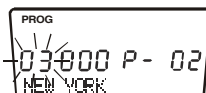

- Repeat above steps 3 to 6, you can program up to 20 tracks.
- After programming is finished, press the PLAY button to begin programmed play.

NOTE:

- Programming can only be done in **STOP** mode.
- The programmed memory will be lost if the STOP button is pressed twice, or the alkaline batteries are exhausted or removed, or AC power is shut off, or the CD DOOR is opened.
- The player will stop automatically after all programmed tracks have been played.

To change the current program

Just create a new program following the programming procedure.

To cancel programmed play

Press the STOP button twice, the symbol **PROG** will disappear from the display.

Basic Introduction to MP3 and WMA

MP3 files are music files which have been compressed into the MP3 format. WMA is the abbreviation for Windows Media Audio. WMA is another audio format, the compression and the audio quality are better than MP3. The CD-2086 plays MP3 & WMA files which have been recorded onto a CD disc.

- The first thing you will need is an IBM compatible PC computer (at least Pentium class) or an apple computer (at least G3 class) with lots of RAM and a CD-R or CD-RW recorder. Then you will need some software. Either it is in your new computer already or you may have to buy this from MusicMatch or a similar company. You may go to the Website www.musicmatch.com or www.nero.com. or www.mp3.com.etc.
 - To play MP3 or WMA files on this player, you will need to make (record) a disc with your MP3 or WMA files (songs) on them.
 - We recommend you get some books or information on the Web to help you learn this way to store & play hundreds of songs in MP3 or WMA format. Also you may search the web for “MP3” or “WMA” and you will immediately find a world of information and songs.
- NOTE:** Most audio CD players can't play MP3 or WMA files, the CD-2086 can play MP3, WMA and normal music files but not if they are mixed on one CD.
- To download an MP3 file (song) from a website (like www.mp3.com), go to <http://www.mp3.com> and you can find a search link at the top of the homepage that allows you to search for MP3 files. Input a key word and click on that link and you will find many songs by many new artists. To download an MP3 file, click on software, then get MP3 link or newer software, register and click on download. We recommend you make a new folder for your MP3 files.
 - Successful recording of a CD needs an uninterrupted stream of high speed data. For best results, limit or close your other programs on the computer while recording to prevent buffer underruns.
 - Pay for downloaded songs, illegal copies of songs are not the correct way to build your song library.
- You can play MP3 or WMA songs on most new computers or you can highlight them for downloading & “burning” (recording) them onto a CD later. Note your CD-2086 will play MP3 or WMA songs which end in the extension “.MP3” (dot MP3) or “.WMA” (dot WMA). You can select how to save a file, select .MP3 or .WMA as the correct extension on your computer. Do not save the file with other extensions like .txt)
 - If you want to convert your existing records or tapes to MP3 discs, you will need to record them using a sound card. You will also need software such as MusicMatch or RealJukebox and a set of audio cables to connect your tape player to your sound card.
 - If you want to record MP3 or WMA files from music CD's, first “rip” (copy) the music onto the hard disc. Ripping is much faster than recording.
 - To record a disc in MP3 or WMA, select a setting in your computer or download an MP3 or WMA creation plug in program to enable recording discs in MP3 or WMA format.
 - Titles and song names can be viewed by the text display of your CD-2086. But in most cases above, you will need to enter the names of the songs. Also, if you put all songs in one album, it may be difficult for you to locate a particular song. We recommend several albums on a single CD with each album containing multiple songs. Cddb (www.cddb.com) is a database which can help you name songs and artists and has useful information on latest songs and artists.
 - Also don't forget your computer savvy friends. Sometimes a friend can show you how to do something easily and quickly, in a few minutes which could take you an hour of reading to learn.

ABOUT “MP3”

WHAT IS MP3?

MP3 (MPEG 1 Audio Layer-3) is a standard technology and format for compressing a sound sequence or song. The file is compressed to about 1/10 of its original size. Sounds outside the range of human hearing are compressed while the sounds we can hear are not compressed.

PLAYABLE “MP3” FILES ON THIS PLAYER

You can only play MP3 files recorded by following requirements.

NOTE: While this player can play most MP3 files it cannot play all files and may not play all MP3 formats.

Usable media

CD-Rs and CD-RWs

Usable disc format

You can use ISO 9660 Level 1/2 and Joliet extension format discs.

The major specification of the usable disc format is:

- Maximum directory steps: 8
- Usable characters for a file/folder name: A - Z, 0 - 9, _ (underscore)
- Maximum number of characters for a file name: 64 and a 3-character extension code

NOTES

- When naming, be sure to add the file extension “mp3” or “wma” to the file name.
- If you put the extension “mp3” to a file other than an MP3 file, the player cannot recognize the file properly.
- The file name does not correspond to the ID tag.

THE USABLE NUMBER OF FOLDERS/FILES

- Maximum number of folders: 511
- Maximum number of files: 511

SETTINGS FOR COMPRESSION SOFTWARE AND WRITING SOFTWARE

- To compress a source for an MP3 file, we recommend setting the transfer bit rate of the compression software to “44.1 kHz”, “128kbps”, and “Constant Bit Rate”.
- Please check the maximum capacity of your CD-R / CD-RW as they come in a different capacity ranges.
- To record at one time up to the maximum capacity on media that has nothing recorded it, set to “Disc at Once”.

NOTES FOR SAVING FILES ON THE MEDIA

When the disc is inserted, the player reads all the files on that disc. If there are many folders or non-MP3/WMA files on the disc, it may take a long time for play to begin or for the next MP3/WMA file to start play.

Do not save unnecessary folders or files other than MP3 or WMA ones in the disc to be used for MP3 listening.

DO NOT record any other files other than MP3 or WMA files on the CD disc. If you record non-mp3 files onto the CD disc, the player may not operate properly. Please record only **MP3** or **WMA** files onto the CD disc.

NOTE: CD-Rs or CD-RWs playback capability at this CD/MP3 player may vary depending on quality of media, CD-Burner, speed of burning and application software.

NOTE: For best results and for the best reading ability, try to make your MP3 recordings at lower speeds. The most accurate speed that we tested for playability is 4X.

NOTE: If you use the new windows media player, you may need to download an “MP3 plug in” to be able to record in MP3 format.

LISTENING TO THE RADIO

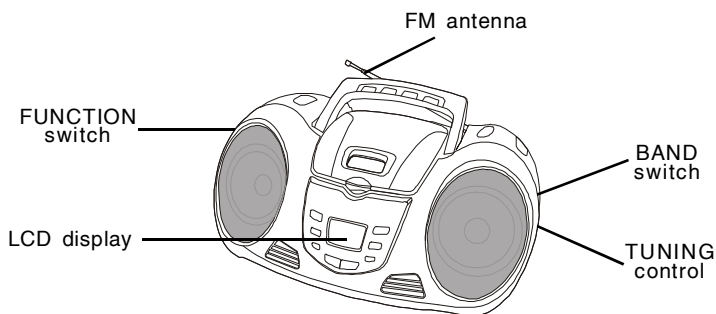

Connect the supplied AC power cord or batteries (refer to page 4).

1

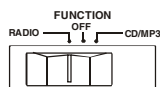

Slide the FUNCTION switch to the RADIO position, the LCD display will turn on, and the current tuner station will show in the display.

2

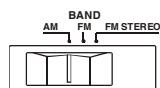

Slide the BAND switch to the proper band position (AM, FM, or FM STEREO) that you want.

3

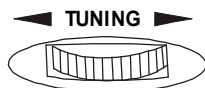

Tune into the station you prefer using the TUNING control. Adjust for the clearest sound. The display will show you the frequency of the station tuned in. This is useful when you know the station's frequency.

NOTE:

This set uses an analog (rotary) tuner with a digital display. The digital display is very useful when locating your favorite station and also assists you to pinpoint the exact tuning frequency. This set does not have radio memory presets.

USE THESE BUTTONS FOR ADDITIONAL OPERATIONS

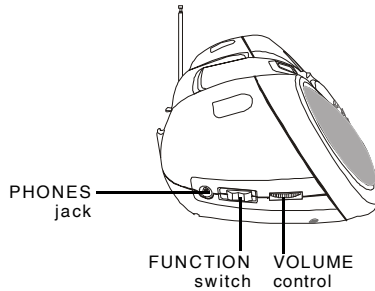

TIP

- If the FM broadcast is noisy, slide the BAND switch from FM Stereo to FM.
- Next time you want to listen to the radio, just slide the FUNCTION switch to the RADIO position. The player will automatically start playing the previously tuned station. You can verify this by seeing the frequency in the display.

To	Slide or Adjust
Adjust the volume	VOLUME control
Turn off the Radio	Slide the FUNCTION switch to OFF position
To enjoy the music without disturbing others	Insert your headphones plug into the PHONES jack (HEADPHONES ARE NOT INCLUDED)

To improve broadcast reception

Change the position of the antenna for FM or FM Stereo. Move the set itself for AM.

NOTE: Extend the FM antenna fully before bending or rotating.

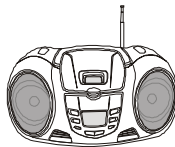

First extend the FM antenna fully.



Then you may bend it or rotate it.



Rotate the set itself for better AM reception.

PRECAUTIONS

On Safety

- Do not open the cabinet. As the laser beam used in the DISC player section may be harmful to the eyes, do not attempt to disassemble the cabinet. Refer servicing to qualified personnel only.
- Should any solid object or liquid fall into the player, unplug the player, and have it checked by qualified personnel before operating it any further.

On Placement

- Do not leave the player in a location near a heat source, or in a place subject to direct sunlight, excessive dust or mechanical shock.
- Do not place the player on an inclined or unstable place.
- Do not place anything within 1 inch of the back of the cabinet. The ventilation holes must not be covered for the player to operate properly and prolong the life of its components.
- If the player is left in a car parked in the sun, be sure to choose a location in the car where the player will not be subjected to the direct rays of the sun.
- Since a strong magnet is used for the speakers, keep personal credit cards using magnetic coding or springwound watches away from the player to prevent possible damage from the magnets.

On Power Sources

- For battery operation, use 8 size “C” batteries. We recommend alkaline batteries for longer life.
- When the batteries will not be used for a few weeks or more, remove them to avoid damage that can be caused by battery leakage or corrosion.

On Operation

- If the player is brought directly from a cold to a warm location, or is placed in a very damp room, moisture may condense on the lens inside the DISC player section. Should this occur, the player will not operate properly. In this case, remove the DISC and wait about an hour for the moisture to evaporate.
- This player has an anti-skip feature, small bumps will not stop the music. However this set must play a few minutes for the anti-skip feature to become active.

MAINTENANCE

Cleaning the lens

A dirty lens will cause sound skipping. If the lens is very dirty, the player may not work. We suggest using a special cleaning disk (not included) available in most music and Hi-Fi stores. However, if you do not have one, you may use a cotton swab very slightly dampened with alcohol to clean the lens.

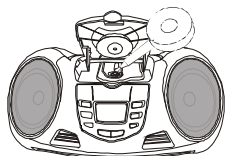

Cleaning the cabinet

Wipe with a soft cloth. If the cabinet is very dirty, dampen (not dripping wet) the cloth with a weak solution of soapy water, and then wipe clean.

Cleaning the Discs

- Fingerprints should be carefully wiped from the surface of disc with a soft cloth. Unlike conventional records, compact discs have no grooves to collect dust and microscopic dirt, so gently wiping them with a soft cloth should remove most particles. Wipe in a straight motion from the center to the edge.

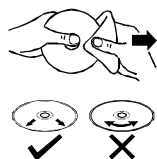

- Never use thinner, benzine, record cleaner or antistatic spray on a compact disc. Such chemicals can damage its plastic surface.

Handling Discs

- Dirty, scratched or warped discs may cause skipping or noise.
- Handle the disc only by the edges. To keep clean, do not touch its surface.



- Discs should be stored in their cases after use to avoid scratches.
- Do not expose discs to direct sunlight, high humidity, high temperatures, or dust, etc. Prolonged exposure to extreme temperatures can warp the disc (such as leaving the discs in your car during summer time).
- Do not stick or write anything on the music side of disc. Sharp writing instruments, or the inks used in some felt-tip pens, may damage its surface.

To remove the Disc

Open the CD DOOR by lifting the **CD DOOR**, hold the disc by the edge while slightly pressing on the center spindle, then lift it from the edge to release and remove.

NOTE

Always press the STOP button and wait for the disc to stop rotating before opening the CD DOOR to remove the disc.

TROUBLE SHOOTING

	Problem	Remedy
General	The power is not on.	<ul style="list-style-type: none"> • Insert the AC plug into a wall outlet securely. • Make sure the batteries are installed correctly and they are fresh.
	There is no sound.	<ul style="list-style-type: none"> • Make sure the FUNCTION switch is at the right position as you want. • Adjust the volume. • Unplug the headphones when listening through speakers.
	“ NO DISC ” or “ BAD DISC ” appears in the display even when a disc is in place.	<ul style="list-style-type: none"> • Insert a CD or an MP3 disc with the label side up. • Sometimes downloaded songs can only play on the computer which downloaded the songs.
CD/MP3 player	Discs do not play.	<ul style="list-style-type: none"> • Make sure that the CD compartment is closed. • Clean the disc. • Take out the disc and leave the CD DOOR open for about an hour to dry moisture condensation. • Make sure the FUNCTION switch is at the CD/MP3 position. • Replace disc (this set will not play damaged or scratched discs), or buy a disc repair polisher to repair it yourself.
	The sound drops out.	<ul style="list-style-type: none"> • Clean the discs, or replace them if the discs are badly damaged. • Place the player in a location with less vibration. • Check if the batteries are fresh. • Your MP3 disc may not be supported on this player. This player will play most standard MP3 discs.
	CD/MP3 does not play while the radio may continue to play.	<ul style="list-style-type: none"> • It is normal since the radio uses less power than the CD/MP3 player.
	MP3 playback does not work or stops.	<ul style="list-style-type: none"> • Re-burn a new MP3 disc. Make sure the disc was recorded in MP3 or WMA format. • Some MP3 songs can not be copied onto discs. This is the new DRM digital rights management to prevent unlimited copies.
Radio	The sound is weak or has poor quality.	<ul style="list-style-type: none"> • Replace all the batteries with new ones if they are weak. • Bring the set near a window, or rotate the set for better AM reception; or draw out the FM antenna for better FM reception.

SPECIFICATION

General Description

Power source: AC 120V, 60Hz
DC 12V (8 size "C" batteries, not included)
(Alkaline batteries are recommended)

Speakers: 2 - 3 1/2" 8 ohm

Output power: 1.8W/channel

Dimensions: Width: 15 1/2"
Depth: 10 3/8"
Height: 6 1/2"
Weight: 5.6 LBs (without batteries)

CD/MP3 Section

Frequency response: 50Hz - 15kHz +/-2dB

Laser wavelength: 760 - 800 NM

Error correction method: CIRC

Pickup: Optical 3-beam semiconductor laser
(780 nm wavelength)

NOTE: CD-Rs or CD-RWs playback capability at this CD/MP3 player may vary depending on quality of media, CD-Burner, speed of burning and application software. Also digital rights management may prevent copying some songs to discs, read the information on the web sites for more information.

Radio Section

Frequency range: FM: 88 - 108 MHz AM: 530 - 1700 kHz

LENOXX reserves the right to make design and specification changes for product improvement.

PROTECT YOUR FINE FURNITURE!

WE RECOMMEND A CLOTH OR OTHER PROTECTIVE MATERIAL BE PLACED UNDER THE SET WHEN PLACING IT ON SURFACE WITH A NATURAL OR LACQUER FINISH.

LIMITED WARRANTY

We warrant this product to be free from defects in material and workmanship under normal use for a period of 90 days after purchase and we will repair it free of charge or replace it at no charge, should it become defective under this warranty, providing you submit proof of purchase (sales slip) with the set.

During the initial 90 day period after original purchase, we will service or exchange, at no charge, the set that is returned to LENOXX ELECTRONICS CORP. After the initial 90 day period expires, and for a period of 12 months from original purchase, we will repair the unit covering any part(s) that need to be replaced at no charge, but will charge for the cost of labor, return postage paid by Lenoxx.

This warranty does not apply to any products which have been subject to misuse, neglect or accident. This warranty does not cover broken cord or cabinet. UNDER NO CIRCUMSTANCES WILL LENOXX ELECTRONICS CORP. BE LIABLE FOR ANY INCIDENTAL OR CONSEQUENTIAL DAMAGES. Some states do not allow the exclusion or limitation of incidental or consequential damages, so the above limitations or exclusions may not apply to you.

This warranty gives you specific legal rights, and you may also have other rights which vary from state to state. The following charges apply to repairs beyond the warranty period: \$15.00. Be sure to pack carefully and return postage paid insured together with your money order (personal checks will not be accepted) and sales receipt to:

LENOXX ELECTRONICS CORP., 2 GERMAK DRIVE, CARTERET N.J. 07008

For Customer Service

Dial 1-800-315-5885

(MONDAY - THURSDAY 9:00 AM - 5:00 PM, FRIDAY 9:00 AM - 1:00 PM EST)

or Visit Our Website: <http://www.lenoxx.com>

© 2005 LENOXX ELECTRONICS CORP.

2 GERMAK DRIVE
CARTERET, N.J. 07008
MADE & PRINTED IN CHINA

— 20 —

IB-CD2086(AD)-WM-E-031705